





THE PERFECT
LIGHTING
SOLUTION FOR
EVERY CONTEXT.

NUMINOS®

ONE LIGHTING SYSTEM – A THOUSAND POSSIBILITIES.

THE FREELY CONFIGURABLE LIGHTING SYSTEM THAT
CASTS A GOOD LIGHT ON EVERY SETTING.

No two projects are the same. But many projects demand a coherent lighting and design concept. NUMINOS® is a perfectly coordinated lighting system that harmonises function, design and technology. For planners and doers. For every need. For maximum variety with minimum effort.

NUMINOS®

HIGH-PERFORMANCE LED MODULE
WITH BRILLIANT COLOUR RENDERING

WIDE SELECTION OF DOWNLIGHTS
AND SPOTS FOR A HARMONIOUS
DESIGN CONCEPT.



MORE FREEDOM WITH SYSTEM.

WHATEVER YOU'RE PLANNING –
THE NUMINOS® LIGHTING SYSTEM
CREATES SPACE FOR NEW IDEAS.



The NUMINOS® lighting system offers constant lighting characteristics and modern design for all uses:

- for office spaces
- shops & boutiques
- hotels & gastronomy
- at home
- and much more

From hotels and offices to commercial or private rooms. From application to technology to detailed design: one great feature is that the modular downlights and spotlights can be configured exactly as required, depending on the design or space in question. And the more multifaceted your project is, the more you benefit from the NUMINOS® lighting system.

Lighting that
won't dominate.



NUMINOS®
GIMBLE M, DL

Product no.
1005945

NUMINOS®
Move S, DL

Product no.
1005340

Highlights that shine down.



NUMINOS® XL, CL
Product no.
1005767

Free for all dimensions.



NUMINOS®
ZOOM M, 3-circuit
Product no.
1006116

Perfect for suspending, and height-adjustable.



NUMINOS® XL, PD
Product no.
1005783

UNPARALLELED VARIETY, SHARED HIGHLIGHTS.

Choose between:

- Downlight or spotlight
- Various sizes and diameters
- Housing colours (black/white)
- Reflector variants
- Pivoting or rigid versions
- Performance classes

The different variants feature:

- High-performance LED module with the light colours 2700K/3000K/4000K
- Colour quality CRI>90
- Glare rating UGR min. <22

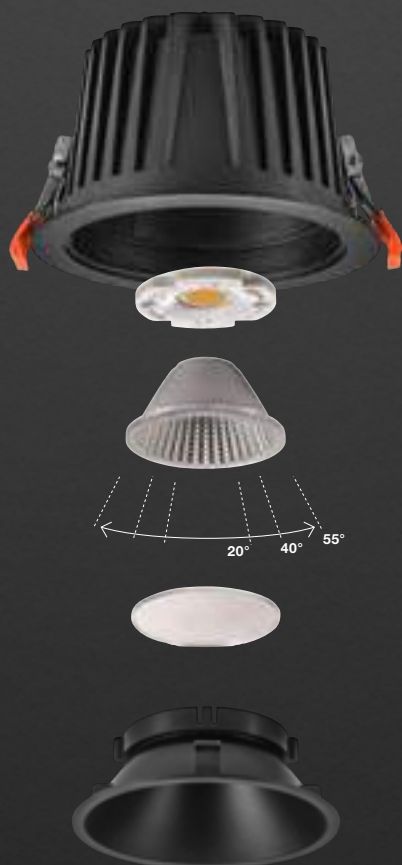

DOWNLIGHTS

Available in seven versions (68-75mm to 176-186mm) with high-performance LED module in three light colours (2700K, 3000K, 4000K) and glare ratings (UGR 16, 19, 22)

Selectable reflectors with half beam angles of 20°, 40° or 55°.

Various effect filters (frosted / prismatic / elliptical / honeycomb) available as accessories.

The decorative ring can be selected in white, black or chrome as a visible border.

NUMINOS® downlights are available as fixed or swivelling versions (4x fixed and 3x swivelling and rotating).



XS S M L XL

Accessories with system:

You can easily add an optional driver (on/off, phase dimming, DALI) and suitable diffusers using the colour coding system.

You can find drivers and diffusers for the SLV NUMINOS® Downlight system on pages 58-61.

A WELL THOUGHT-OUT LIGHTING SYSTEM DOWN TO THE LAST DETAIL.

Thanks to the wide selection of modules, there is a suitable solution to meet every need. Fixed configuration. Fast and safe to install.

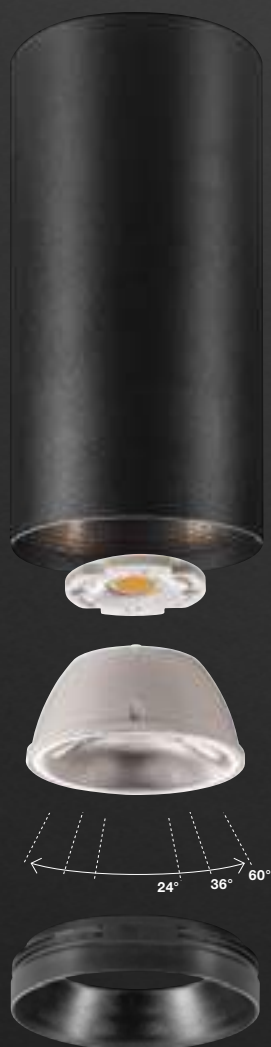

SPOTLIGHTS

Available in three housing sizes (65x155mm, 85x175mm, 100x203mm) with high-power LED module in three light colours (2700K, 3000K, 4000K)

Thanks to the built-in LED driver (phase dimming, DALI), all spotlights are suitable for direct connection to 230V mains voltage.

Selectable lenses with half beam angles of 24°, 36° or 60°.

NUMINOS® spotlights are available as swivelling or fixed ceiling spots, pendant lights and as spots for 3-circuit track systems.



Easy to install.

Because efficiency always pays off, SLV lights are easy, quick and safe to install. Connection via mounting plate, rail system, quick-release coupling, spring clips and colour-coded drivers for downlights offers a key advantage: it saves you time and effort – and therefore costs.



A LIGHTING SYSTEM. FOR EVERY SCENARIO.

For success in all conditions, you need team players who shine with individual strengths. Discover the applications for which the individual NUMINOS® lights are particularly well suited.



Transform objects into eye-catching features



NUMINOS®
GIMBLE XS, DL
Product no.
1005817

Downlights.

Unobtrusive, modern and space-saving lighting that directs the gaze to particular objects or the room in general: the downlights in the NUMINOS® lighting system can be used variably in commercial and private settings.



For elegant illumination of lounge areas.



NUMINOS®
GIMBLE XS, DL
Product no.
1005843

For entrance areas
that really welcome
guests in.



NUMINOS® XS
DL
Product no.
1005520



Guide the way
in hallways.



NUMINOS®
MOVE XS, DL
Product no.
1005584

To create accents
in sales areas.



NUMINOS®
GIMBLE M, DL
Product no.
1005953

Individually designed illumination.

Thanks to the large selection of reflectors on offer, the NUMINOS® lighting system is suitable for accent lighting as well as for the illumination of products and sales areas.

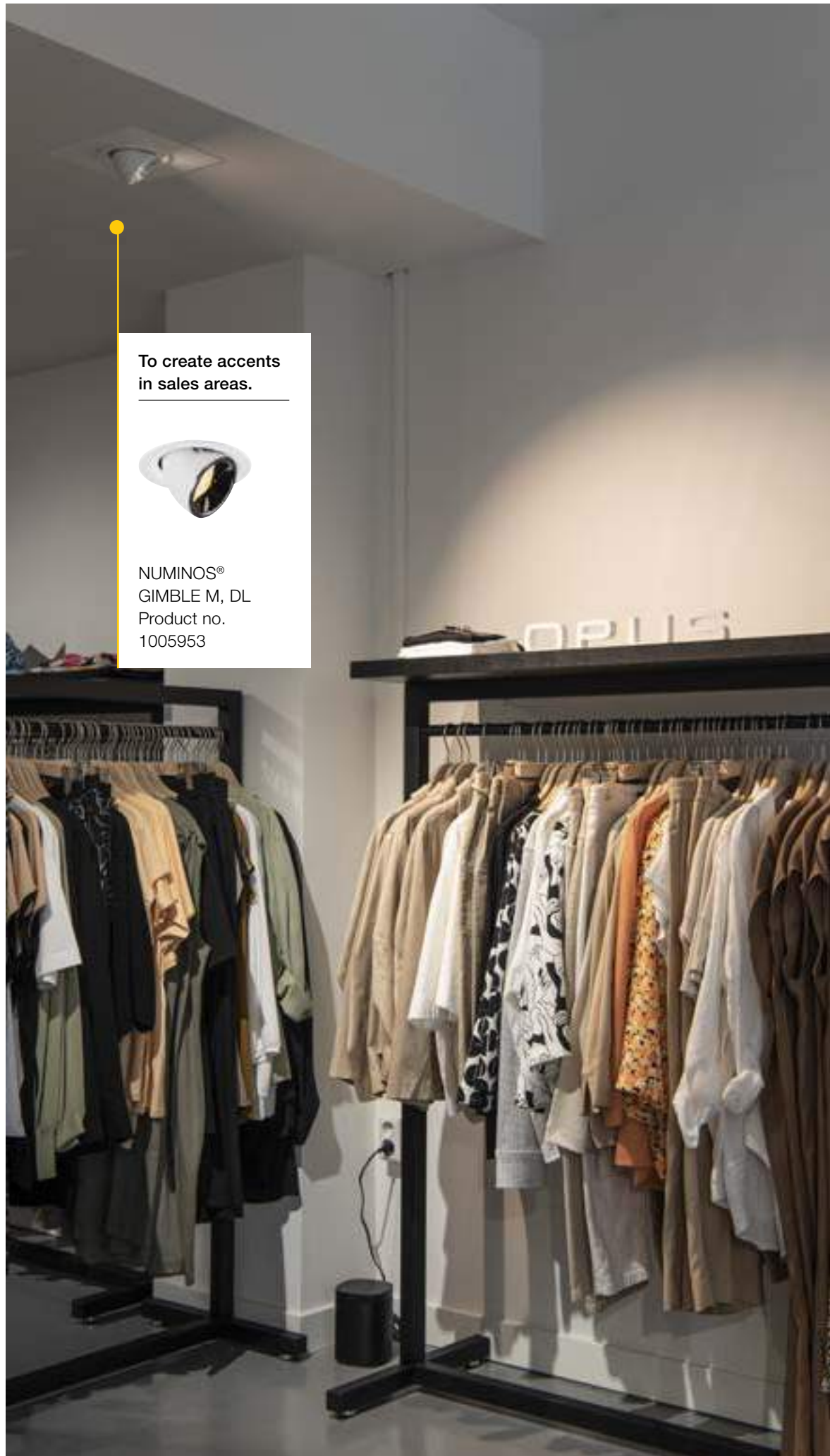

For the perfect
presentation of
objects.



NUMINOS®
GIMBLE S, DL
Product no.
1005899

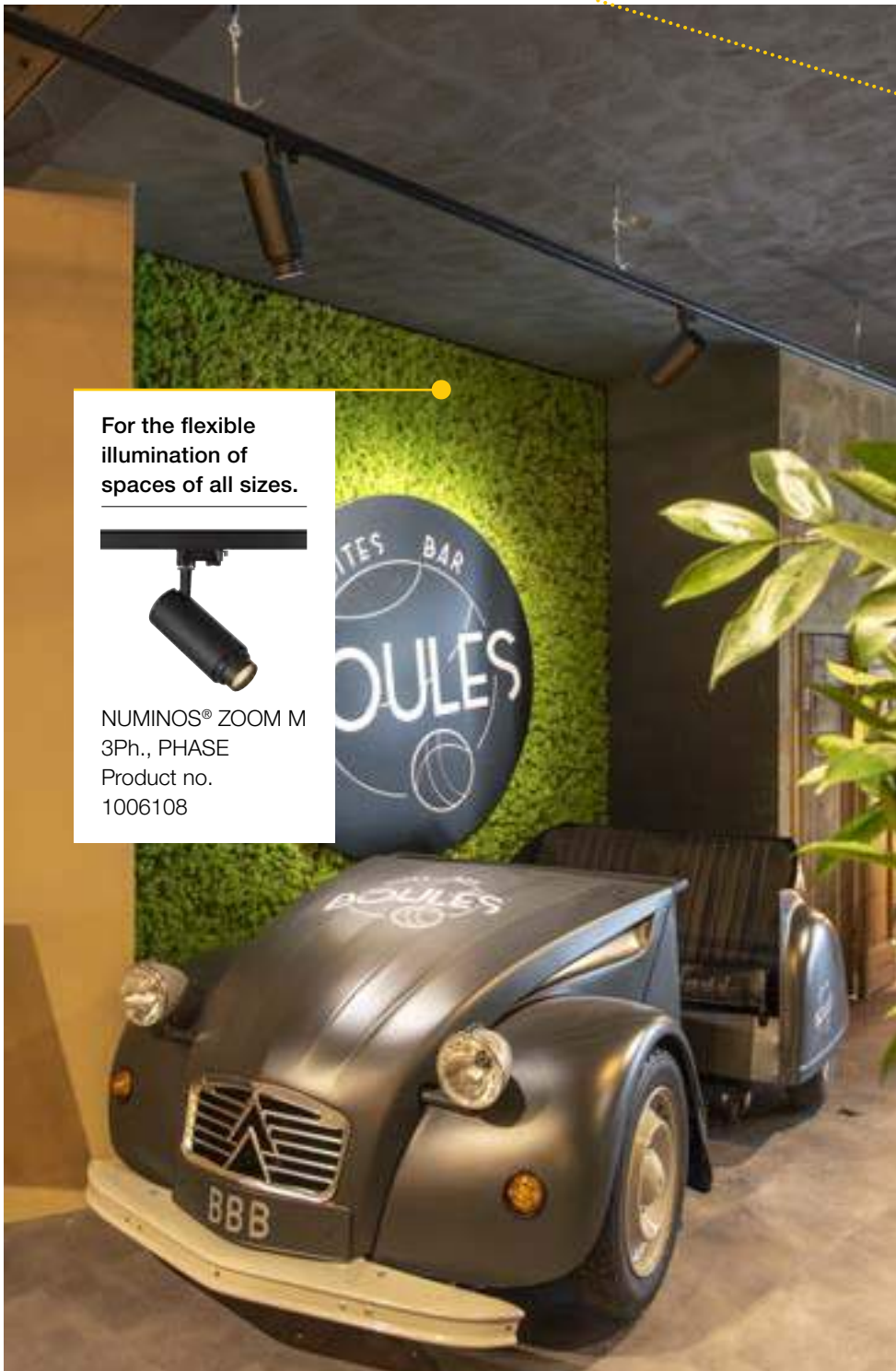

For the flexible illumination of spaces of all sizes.



NUMINOS® ZOOM M
3Ph., PHASE
Product no.
1006108

Products skilfully showcased.



NUMINOS® ZOOM M
3-circuit., DALI
Product no.
1006119

Spotlights.

Shops and boutiques as well as restaurants, bars, museums, studios, and surgeries – every space depends on expert accent lighting. Spotlights can be used to illuminate larger spaces as well as for targeted lighting.





To create
an appetising
atmosphere.



NUMINOS® M
PD, PHASE
Product no.
1004247
combined with
decorative ring
Product no.
1006168



For a cosier home.



NUMINOS® S, PD, DALI
Prod. no.: 1004439
combined with decorative ring
Prod. no.: 1006167



SYSTEMATICALLY ACHIEVING YOUR OBJECTIVE.

With the NUMINOS® Online Configurator.

Our configurator really is this easy:
the first question is: downlight or spotlight?
You can then choose between preconfigured
and additionally customisable application
scenarios or free configuration.

If you are still unsure about the selection
of attributes, don't worry: we offer suitable
explanations for each selected configuration.

This way to the NUMINOS® Configurator:

www.numinos.SLV.com

Just three steps to reach your goal:

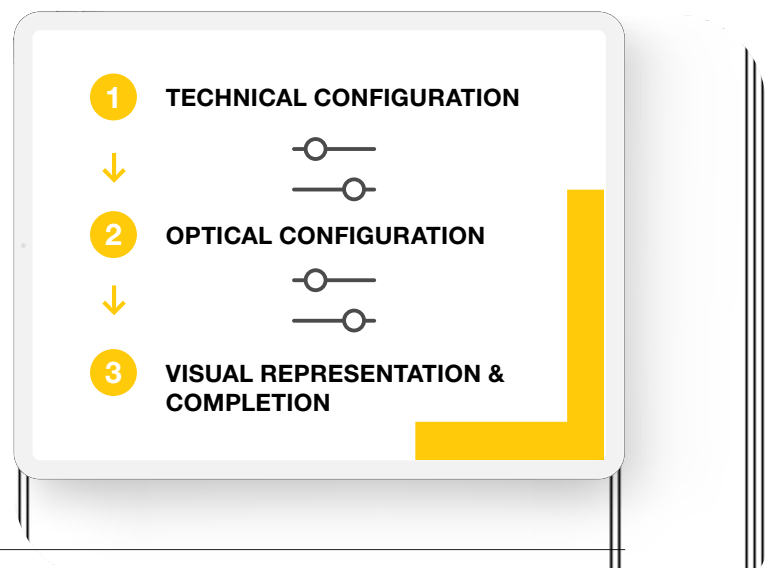

Reach your goal here and now – configure your lighting with the BIG WHITE® catalogue.

Put together your dream lighting over the next pages. The following product overviews will help you reach your goal just as easily: scroll to your desired light type, follow the columns from left to right and make your individual selection. At the end, you will find the relevant item number for direct ordering.

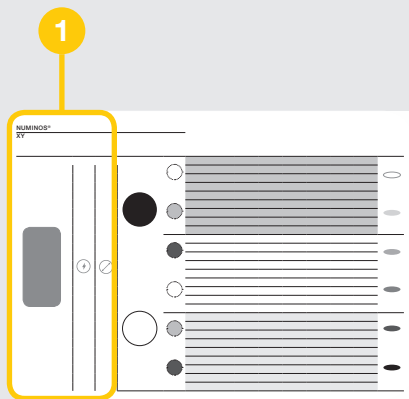

STEP 1

SPOTLIGHT OR DOWNLIGHT?

Choose the most suitable light type for your needs. The diameter (downlights) or housing size (spotlights) are coupled with the total wattage.

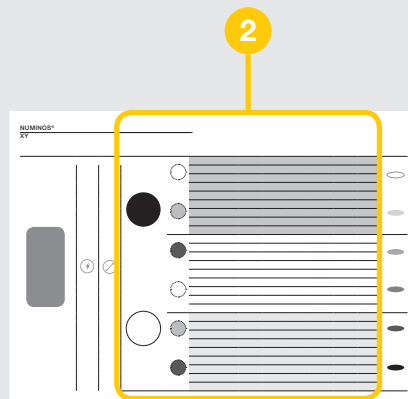

STEP 2

TECHNICAL CONFIGURATION & SELECTION OF DETAILS

Column by column, you can select optical and technical attributes such as housing colour or decorative colours, the colour temperature, half beam angle and more.

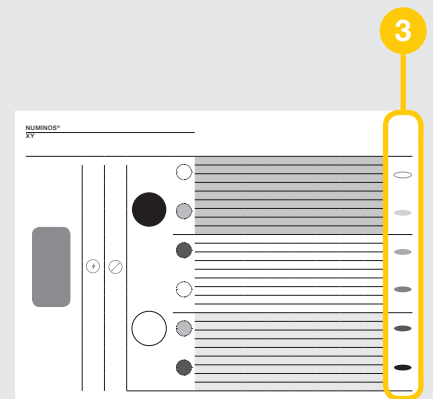

STEP 3

PRODUCT

Get a visual impression of your fully configured light and order it right away using the relevant item number.

STILL UNSURE ABOUT SOMETHING?

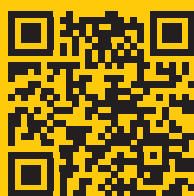



Scan me to view a video that shows how to configure NUMINOS® lights.

In addition to the familiar catalog icons, you will find the following icons in this chapter:

-  **Glare rating**

-  **Colour temperature**

-  **Beam angle**

-  **Lumen**

-  **Controller**

NUMINOS® XS

NEW VARIANT



DL

XS



Product details:

200mA

Power consumption: 7W

Material: aluminium/polycarbonate (PC)

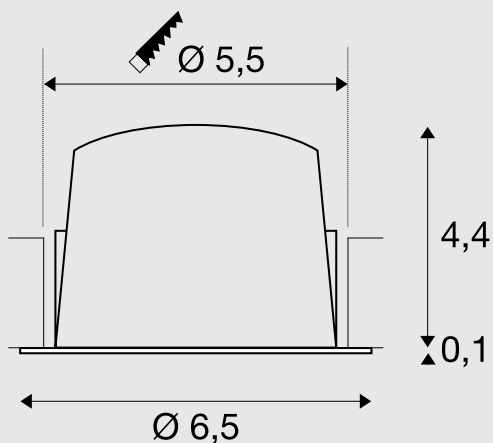
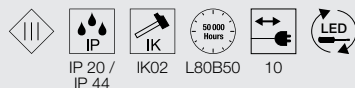

Tip:

Low-voltage plug
 Driver not included
 Leaf springs are included with the product and can be replaced.

You can find suitable drivers, diffusers, and reducer rings on pages 58-61.



black

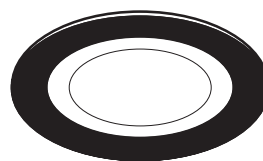

black



white



chrome



black

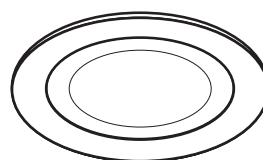

white



white



chrome

A → G				UGR	PROD. NO.		
A ↑ G	2700 K	640lm	20°	16	1005499		
		620lm	40°	22	1005502		
		640lm	55°	25	1005505		
A ↑ G	3000 K	700lm	20°	16	1005517		
		670 lm	40°	22	1005520		
		690lm	55°	25	1005523		
A ↑ G	4000 K	720lm	20°	16	1005535		
		700lm	40°	22	1005538		
		710lm	55°	25	1005541		
A ↑ G	2700 K	670 lm	20°	16	1005500		
		650lm	40°	22	1005503		
		670 lm	55°	25	1005506		
A ↑ G	3000 K	730lm	20°	16	1005518		
		700lm	40°	22	1005521		
		720lm	55°	25	1005524		
A ↑ G	4000 K	750lm	20°	16	1005536		
		730lm	40°	22	1005539		
		740lm	55°	25	1005542		
A ↑ G	2700 K	670 lm	20°	16	1005501		
		650lm	40°	22	1005504		
		670 lm	55°	25	1005507		
A ↑ G	3000 K	730lm	20°	16	1005519		
		700lm	40°	22	1005522		
		720lm	55°	25	1005525		
A ↑ G	4000 K	750lm	20°	16	1005537		
		730lm	40°	22	1005540		
		740lm	55°	25	1005543		
A ↑ G	2700 K	640lm	20°	16	1005508		
		620lm	40°	22	1005511		
		640lm	55°	25	1005514		
A ↑ G	3000 K	700lm	20°	16	1005526		
		670 lm	40°	22	1005529		
		690lm	55°	25	1005532		
A ↑ G	4000 K	720lm	20°	16	1005544		
		700lm	40°	22	1005547		
		710lm	55°	25	1005550		
A ↑ G	2700 K	670 lm	20°	16	1005509		
		650lm	40°	22	1005512		
		670 lm	55°	25	1005515		
A ↑ G	3000 K	730lm	20°	16	1005527		
		700lm	40°	22	1005530		
		720lm	55°	25	1005533		
A ↑ G	4000 K	750lm	20°	16	1005545		
		730lm	40°	22	1005548		
		740lm	55°	25	1005551		
A ↑ G	2700 K	670 lm	20°	16	1005510		
		650lm	40°	22	1005513		
		670 lm	55°	25	1005516		
A ↑ G	3000 K	730lm	20°	16	1005528		
		700lm	40°	22	1005531		
		720lm	55°	25	1005534		
A ↑ G	4000 K	750lm	20°	16	1005546		
		730lm	40°	22	1005549		
		740lm	55°	25	1005552		

NUMINOS® S



DL



Product details:

250mA

Power consumption: 8.6W

Material: aluminium/polycarbonate (PC)

Installation dimensions: Diameter: 6.8 cm D: 5.5 cm

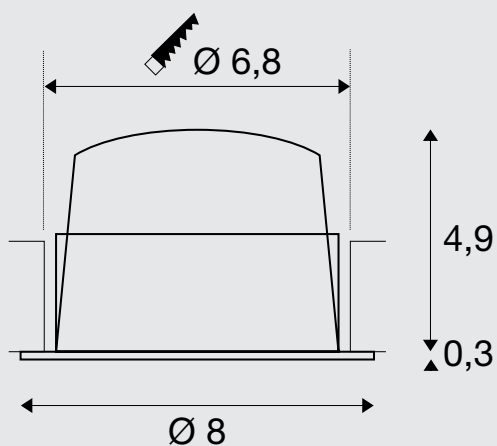
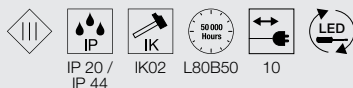

Tip:

Low-voltage plug
Driver not included
Leaf springs are included with the product and can be replaced.

You can find suitable drivers, diffusers, and reducer rings on pages 58-61.



black

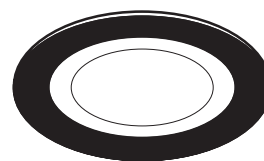

black



white



chrome



black

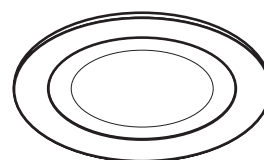

white



white



chrome

					PROD. NO.		
	2700 K	670 lm	20°	19	1003769		
		670 lm	40°	18,5	1003772		
		670 lm	55°	22	1003775		
	3000 K	690lm	20°	19	1003793		
		690lm	40°	19	1003796		
		690lm	55°	22	1003799		
	4000 K	730lm	20°	19	1003817		
		730lm	40°	19	1003820		
		730lm	55°	22	1003823		
	2700 K	720lm	20°	18,5	1003770		
		720lm	40°	19	1003773		
		720lm	55°	22	1003776		
	3000 K	730lm	20°	19	1003794		
		730lm	40°	19	1003797		
		730lm	55°	22	1003800		
	4000 K	790lm	20°	19	1003818		
		790lm	40°	19	1003821		
		790lm	55°	22	1003824		
	2700 K	690lm	20°	19	1003771		
		690lm	40°	19	1003774		
		690lm	55°	22	1003777		
	3000 K	700lm	20°	19	1003795		
		700lm	40°	19	1003798		
		700lm	55°	19	1003801		
	4000 K	750lm	20°	19	1003819		
		750lm	40°	19	1003822		
		750lm	55°	22	1003825		
	2700 K	670 lm	20°	19	1003781		
		670 lm	40°	19	1003784		
		670 lm	55°	22	1003787		
	3000 K	690lm	20°	19	1003805		
		690lm	40°	19	1003808		
		690lm	55°	22	1003811		
	4000 K	730lm	20°	19	1003829		
		730lm	40°	19	1003832		
		730lm	55°	22	1003835		
	2700 K	720lm	20°	18,5	1003782		
		720lm	40°	19	1003785		
		720lm	55°	22	1003788		
	3000 K	730lm	20°	19	1003806		
		730lm	40°	19	1003809		
		730lm	55°	22	1003812		
	4000 K	790lm	20°	19	1003830		
		790lm	40°	19	1003833		
		790lm	55°	22	1003836		
	2700 K	690lm	20°	19	1003783		
		690lm	40°	19	1003786		
		690lm	55°	22	1003789		
	3000 K	700lm	20°	19	1003807		
		700lm	40°	19	1003810		
		700lm	55°	22	1003813		
	4000 K	750lm	20°	19	1003831		
		750lm	40°	19	1003834		
		750lm	55°	22	1003837		

NUMINOS® M



DL

M



Product details:

500mA
 Power consumption: 17.5W
 Material: aluminium/polycarbonate (PC)
 Installation dimensions: Diameter: 9 cm D: 7.5 cm

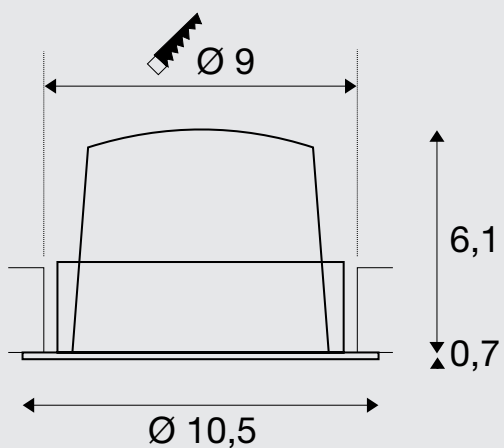
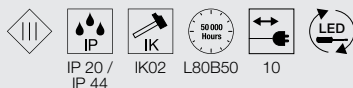

Tip:

Low-voltage plug
 Driver not included
 Leaf springs are included with the product and can be replaced.

You can find suitable drivers, diffusers, and reducer rings on pages 58-61.



black

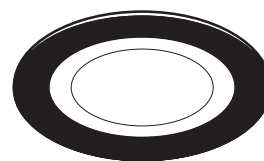

black



white



chrome



black

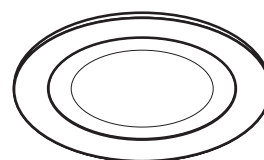

white



white



chrome

					PROD. NO.		
	2700 K	1460lm	20°	19	1003841		
		1460lm	40°	22	1003844		
		1460lm	55°	22	1003847		
	3000 K	1500lm	20°	19	1003865		
		1500lm	40°	22	1003868		
		1500lm	55°	22	1003871		
	4000 K	1600lm	20°	19	1003889		
		1600lm	40°	22	1003892		
		1600lm	55°	22	1003895		
	2700 K	1600lm	20°	22	1003842		
		1600lm	40°	19,4	1003845		
		1600lm	55°	22	1003848		
	3000 K	1600lm	20°	22	1003866		
		1600lm	40°	22	1003869		
		1600lm	55°	22	1003872		
	4000 K	1750lm	20°	22	1003890		
		1750lm	40°	22	1003893		
		1750lm	55°	22	1003896		
	2700 K	1550lm	20°	19	1003843		
		1550lm	40°	19	1003846		
		1550lm	55°	19	1003849		
	3000 K	1550lm	20°	19	1003867		
		1550lm	40°	19	1003870		
		1550lm	55°	19	1003873		
	4000 K	1660lm	20°	19	1003891		
		1660lm	40°	19	1003894		
		1660lm	55°	19	1003897		
	2700 K	1460lm	20°	19	1003853		
		1460lm	40°	22	1003856		
		1460lm	55°	22	1003859		
	3000 K	1500lm	20°	19	1003877		
		1500lm	40°	22	1003880		
		1500lm	55°	22	1003883		
	4000 K	1600lm	20°	19	1003901		
		1600lm	40°	22	1003904		
		1600lm	55°	22	1003907		
	2700 K	1600lm	20°	22	1003854		
		1600lm	40°	19	1003857		
		1600lm	55°	22	1003860		
	3000 K	1600lm	20°	22	1003878		
		1600lm	40°	22	1003881		
		1600lm	55°	22	1003884		
	4000 K	1750lm	20°	22	1003902		
		1750lm	40°	22	1003905		
		1750lm	55°	22	1003908		
	2700 K	1550lm	20°	19	1003855		
		1550lm	40°	19	1003858		
		1550lm	55°	19	1003861		
	3000 K	1550lm	20°	19	1003879		
		1550lm	40°	19	1003882		
		1550lm	55°	19	1003885		
	4000 K	1660lm	20°	19	1003903		
		1660lm	40°	19	1003906		
		1660lm	55°	19	1003909		

NUMINOS® L



DL



Product details:

700mA
 Power consumption: 25.4W
 Material: aluminium/polycarbonate (PC)
 Installation dimensions: Diameter: 11.7 cm D: 9 cm

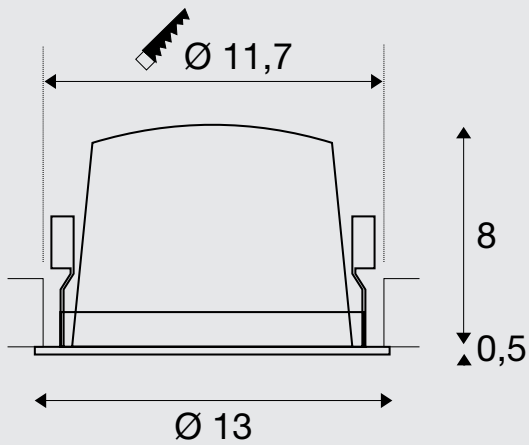

Tip:
 Low-voltage plug
 Driver not included

You can find suitable drivers, diffusers, and reducer rings on pages 58-61.

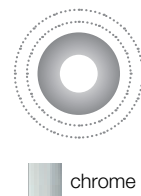
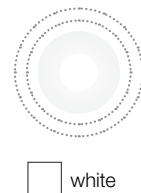
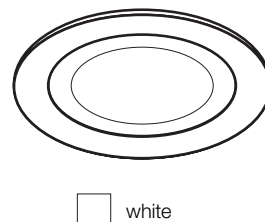
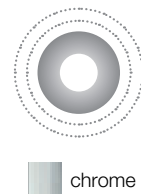
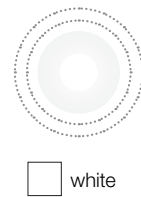
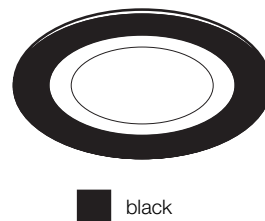

					PROD. NO.		
	2700 K	2150lm	20°	22	1003913		
		2150lm	40°	22	1003916		
		2150lm	55°	22	1003919		
	3000 K	2150lm	20°	22	1003937		
		2150lm	40°	22	1003940		
		2150lm	55°	25	1003943		
	4000 K	2350lm	20°	22	1003961		
		2350lm	40°	22	1003964		
		2350lm	55°	25	1003967		
	2700 K	2250lm	20°	19	1003914		
		2250lm	40°	19	1003917		
		2250lm	55°	22	1003920		
	3000 K	2300lm	20°	19	1003938		
		2300lm	40°	19	1003941		
		2300lm	55°	20	1003944		
	4000 K	2450lm	20°	19	1003962		
		2450lm	40°	19	1003965		
		2450lm	55°	22	1003968		
	2700 K	2150lm	20°	19	1003915		
		2150lm	40°	19	1003918		
		2150lm	55°	19	1003921		
	3000 K	2200lm	20°	19	1003939		
		2200lm	40°	19	1003942		
		2200lm	55°	19	1003945		
	4000 K	2350lm	20°	19	1003963		
		2350lm	40°	19	1003966		
		2350lm	55°	19	1003969		
	2700 K	2150lm	20°	22	1003925		
		2150lm	40°	22	1003928		
		2150lm	55°	22	1003931		
	3000 K	2150lm	20°	22	1003949		
		2150lm	40°	22	1003952		
		2150lm	55°	25	1003955		
	4000 K	2350lm	20°	22	1003973		
		2350lm	40°	22	1003976		
		2350lm	55°	25	1003979		
	2700 K	2250lm	20°	19	1003926		
		2250lm	40°	19	1003929		
		2250lm	55°	22	1003932		
	3000 K	2300lm	20°	19	1003950		
		2300lm	40°	19	1003953		
		2300lm	55°	22	1003956		
	4000 K	2450lm	20°	19	1003974		
		2450lm	40°	19	1003977		
		2450lm	55°	22	1003980		
	2700 K	2150lm	20°	19	1003927		
		2150lm	40°	19	1003930		
		2150lm	55°	19	1003933		
	3000 K	2200lm	20°	19	1003951		
		2200lm	40°	19	1003954		
		2200lm	55°	19	1003957		
	4000 K	2350lm	20°	19	1003975		
		2350lm	40°	19	1003978		
		2350lm	55°	19	1003981		

NUMINOS® XL



DL

XL



Product details:

1050mA
 Power consumption: 37.4W
 Material: aluminium/polycarbonate (PC)
 Installation dimensions: Diameter: 14.5 cm D: 11.5 cm

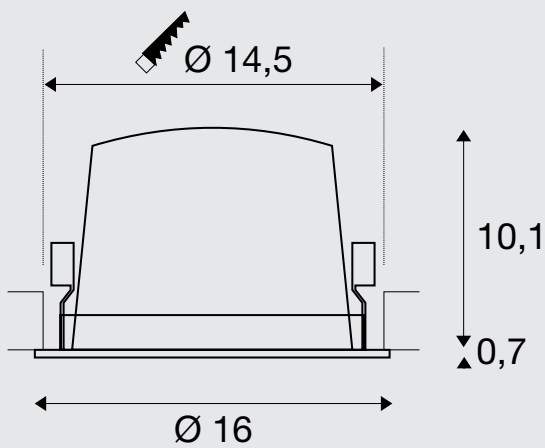

Tip:

Low-voltage plug
 Driver not included

You can find suitable drivers, diffusers, and reducer rings on pages 58-61.

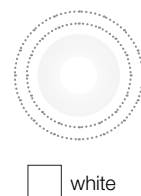
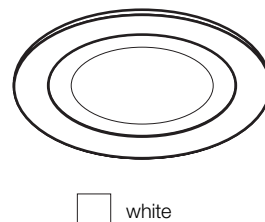
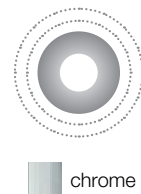
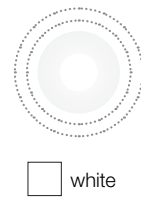
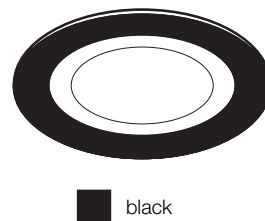
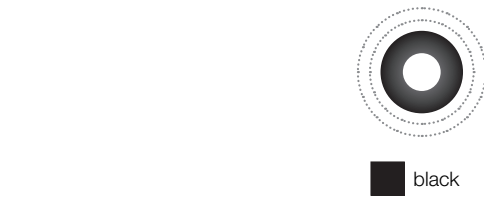

A → G				UGR	PROD. NO.	
A ↑ G	2700 K	3300lm	20°	22	1003985	
		3300lm	40°	22	1003988	
		3300lm	55°	22	1003991	
A ↑ G	3000 K	3300lm	20°	22	1004009	
		3300lm	40°	22	1004012	
		3300lm	55°	22	1004015	
A ↑ G	4000 K	3600lm	20°	22	1004033	
		3600lm	40°	22	1004036	
		3600lm	55°	25	1004039	
A ↑ G	2700 K	3500lm	20°	19	1003986	
		3500lm	40°	19	1003989	
		3500lm	55°	19	1003992	
A ↑ G	3000 K	3550lm	20°	19	1004010	
		3550lm	40°	19	1004013	
		3550lm	55°	19	1004016	
A ↑ G	4000 K	3800lm	20°	19	1004034	
		3800lm	40°	19	1004037	
		3800lm	55°	19	1004040	
A ↑ G	2700 K	3400lm	20°	19	1003987	
		3400lm	40°	19	1003990	
		3400lm	55°	19	1003993	
A ↑ G	3000 K	3500lm	20°	19	1004011	
		3500lm	40°	19	1004014	
		3500lm	55°	19	1004017	
A ↑ G	4000 K	3750lm	20°	19	1004035	
		3750lm	40°	19	1004038	
		3750lm	55°	19	1004041	
A ↑ G	2700 K	3300lm	20°	22	1003997	
		3300lm	40°	22	1004000	
		3300lm	55°	22	1004003	
A ↑ G	3000 K	3300lm	20°	22	1004021	
		3300lm	40°	22	1004024	
		3300lm	55°	22	1004027	
A ↑ G	4000 K	3600lm	20°	22	1004045	
		3600lm	40°	22	1004048	
		3600lm	55°	25	1004051	
A ↑ G	2700 K	3500lm	20°	19	1003998	
		3500lm	40°	19	1004001	
		3500lm	55°	19	1004004	
A ↑ G	3000 K	3550lm	20°	19	1004022	
		3550lm	40°	19	1004025	
		3550lm	55°	19	1004028	
A ↑ G	4000 K	3800lm	20°	19	1004046	
		3800lm	40°	19	1004049	
		3800lm	55°	19	1004052	
A ↑ G	2700 K	3400lm	20°	19	1003999	
		3400lm	40°	19	1004002	
		3400lm	55°	19	1004005	
A ↑ G	3000 K	3500lm	20°	19	1004023	
		3500lm	40°	19	1004026	
		3500lm	55°	19	1004029	
A ↑ G	4000 K	3750lm	20°	19	1004047	
		3750lm	40°	19	1004050	
		3750lm	55°	19	1004053	

NUMINOS® MOVE XS

NEW VARIANT



DL

XS



Product details:

200mA

Power consumption: 7W

Material: aluminium/polycarbonate (PC)

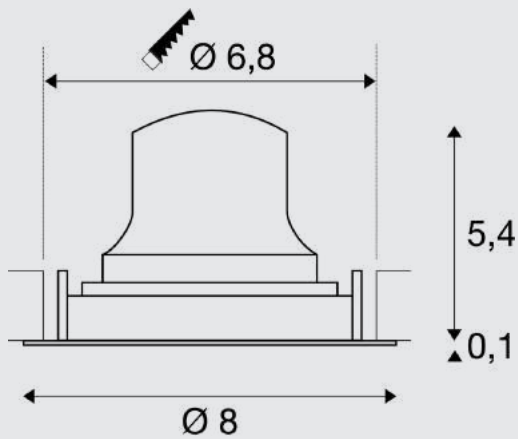

Tip:

Low-voltage plug
Driver not included

You can find suitable drivers, diffusers, and reducer rings on pages 58-61.

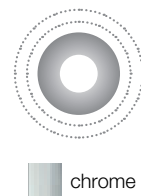
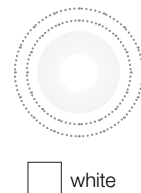
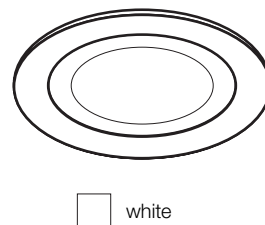
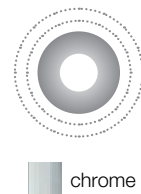
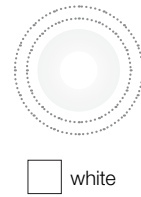
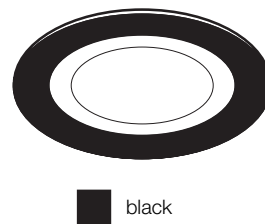

A → G				UGR	PROD. NO.	
A ↑ G	2700 K	640lm	20°	16	1005553	
		620lm	40°	22	1005556	
		640lm	55°	25	1005559	
A ↑ G	3000 K	700lm	20°	16	1005571	
		670lm	40°	22	1005574	
		690lm	55°	25	1005577	
A ↑ G	4000 K	720lm	20°	16	1005589	
		700lm	40°	22	1005592	
		710lm	55°	25	1005595	
A ↑ G	2700 K	670lm	20°	16	1005554	
		650lm	40°	22	1005557	
		670lm	55°	25	1005560	
A ↑ G	3000 K	730lm	20°	16	1005572	
		700lm	40°	22	1005575	
		720lm	55°	25	1005578	
A ↑ G	4000 K	750lm	20°	16	1005590	
		730lm	40°	22	1005593	
		740lm	55°	25	1005596	
A ↑ G	2700 K	670lm	20°	16	1005555	
		650lm	40°	22	1005558	
		670lm	55°	25	1005561	
A ↑ G	3000 K	730lm	20°	16	1005573	
		700lm	40°	22	1005576	
		720lm	55°	25	1005579	
A ↑ G	4000 K	750lm	20°	16	1005591	
		730lm	40°	22	1005594	
		740lm	55°	25	1005597	
A ↑ G	2700 K	640lm	20°	16	1005562	
		620lm	40°	22	1005565	
		640lm	55°	25	1005568	
A ↑ G	3000 K	700lm	20°	16	1005580	
		670lm	40°	22	1005583	
		690lm	55°	25	1005586	
A ↑ G	4000 K	720lm	20°	16	1005598	
		700lm	40°	22	1005603	
		710lm	55°	25	1005606	
A ↑ G	2700 K	670lm	20°	16	1005563	
		650lm	40°	22	1005566	
		670lm	55°	25	1005569	
A ↑ G	3000 K	730lm	20°	16	1005581	
		700lm	40°	22	1005584	
		720lm	55°	25	1005587	
A ↑ G	4000 K	750lm	20°	16	1005599	
		730lm	40°	22	1005604	
		740lm	55°	25	1005607	
A ↑ G	2700 K	670lm	20°	16	1005564	
		650lm	40°	22	1005567	
		670lm	55°	25	1005570	
A ↑ G	3000 K	730lm	20°	16	1005582	
		700lm	40°	22	1005585	
		720lm	55°	25	1005588	
A ↑ G	4000 K	750lm	20°	16	1005600	
		730lm	40°	22	1005605	
		740lm	55°	25	1005608	

NUMINOS® MOVE S

NEW VARIANT



DL

S



Product details:

250 mA

Power consumption: 8.6W

Material: aluminium/polycarbonate (PC)

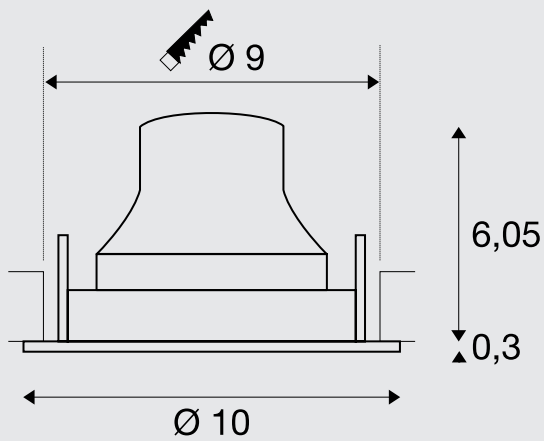

Tip:

Low-voltage plug
Driver not included

You can find suitable drivers, diffusers, and reducer rings on pages 58-61.

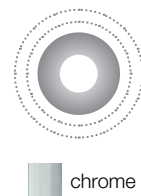
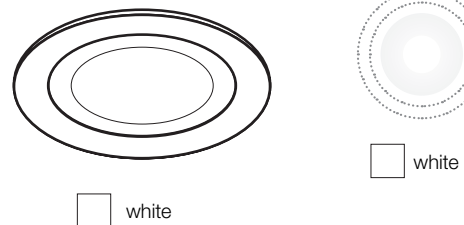
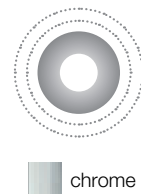
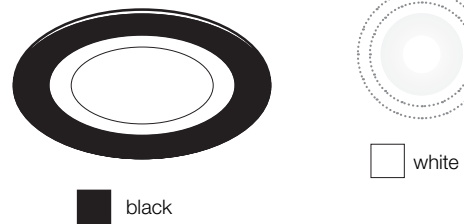

A → G				UGR	PROD. NO.		
A ↑ G	2700 K	670 lm	20°	19	1005319		
		670 lm	40°	19	1005322		
		670 lm	55°	22	1005325		
A ↑ G	3000 K	690lm	20°	19	1005337		
		690lm	40°	19	1005340		
		690lm	55°	22	1005343		
A ↑ G	4000 K	730lm	20°	19	1005355		
		730lm	40°	19	1005358		
		730lm	55°	22	1005361		
A ↑ G	2700 K	720lm	20°	19	1005320		
		720lm	40°	19	1005323		
		720lm	55°	22	1005326		
A ↑ G	3000 K	730lm	20°	19	1005338		
		730lm	40°	19	1005341		
		730lm	55°	22	1005344		
A ↑ G	4000 K	790lm	20°	19	1005356		
		790lm	40°	19	1005359		
		790lm	55°	22	1005362		
A ↑ G	2700 K	690lm	20°	19	1005321		
		690lm	40°	19	1005324		
		690lm	55°	22	1005327		
A ↑ G	3000 K	700lm	20°	19	1005339		
		700lm	40°	19	1005342		
		700lm	55°	22	1005345		
A ↑ G	4000 K	750lm	20°	19	1005357		
		750lm	40°	19	1005360		
		750lm	55°	22	1005363		
A ↑ G	2700 K	670 lm	20°	19	1005328		
		670 lm	40°	19	1005331		
		670 lm	55°	22	1005334		
A ↑ G	3000 K	690lm	20°	19	1005346		
		690lm	40°	19	1005349		
		690lm	55°	22	1005352		
A ↑ G	4000 K	730lm	20°	19	1005364		
		730lm	40°	19	1005367		
		730lm	55°	22	1005370		
A ↑ G	2700 K	720lm	20°	19	1005329		
		720lm	40°	19	1005332		
		720lm	55°	22	1005335		
A ↑ G	3000 K	730lm	20°	19	1005347		
		730lm	40°	19	1005350		
		730lm	55°	22	1005353		
A ↑ G	4000 K	790lm	20°	19	1005365		
		790lm	40°	19	1005368		
		790lm	55°	22	1005371		
A ↑ G	2700 K	690lm	20°	19	1005330		
		690lm	40°	19	1005333		
		690lm	55°	22	1005336		
A ↑ G	3000 K	700lm	20°	19	1005348		
		700lm	40°	19	1005351		
		700lm	55°	22	1005354		
A ↑ G	4000 K	750lm	20°	19	1005366		
		750lm	40°	19	1005369		
		750lm	55°	22	1005372		

NUMINOS® MOVE M



DL

M



Product details:

500mA
 Power consumption: 17.5W
 Material: aluminium/polycarbonate (PC)
 Installation dimensions: Diameter: 12 cm D: 10 cm

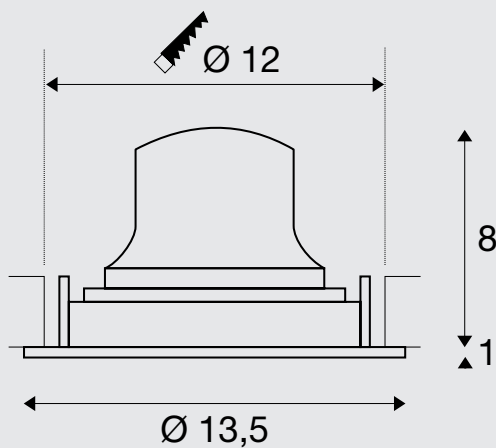

Tip:
 Low-voltage plug
 Driver not included

You can find suitable drivers, diffusers, and reducer rings on pages 58-61.

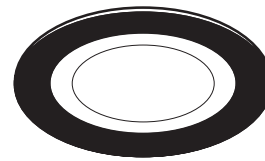

black



white



chrome



black

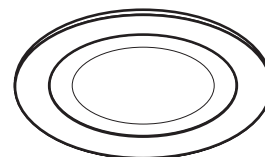

white



white



chrome

A → G				UGR	PROD. NO.	
	2700 K	1460lm	20°	19	1003553	
		1460lm	40°	22	1003556	
		1460lm	55°	22	1003559	
	3000 K	1500lm	20°	19	1003577	
		1500lm	40°	22	1003580	
		1500lm	55°	22	1003583	
	4000 K	1600lm	20°	19	1003601	
		1600lm	40°	22	1003604	
		1600lm	55°	22	1003607	
	2700 K	1600lm	20°	22	1003554	
		1600lm	40°	19	1003557	
		1600lm	55°	22	1003560	
	3000 K	1600lm	20°	22	1003578	
		1600lm	40°	22	1003581	
		1600lm	55°	22	1003584	
	4000 K	1750lm	20°	22	1003602	
		1750lm	40°	22	1003605	
		1750lm	55°	22	1003608	
	2700 K	1550lm	20°	19	1003555	
		1550lm	40°	19	1003558	
		1550lm	55°	19	1003561	
	3000 K	1550lm	20°	19	1003579	
		1550lm	40°	19	1003582	
		1550lm	55°	19	1003585	
	4000 K	1660lm	20°	19	1003603	
		1660lm	40°	19	1003606	
		1660lm	55°	19	1003609	
	2700 K	1460lm	20°	19	1003565	
		1460lm	40°	22	1003568	
		1460lm	55°	22	1003571	
	3000 K	1500lm	20°	19	1003589	
		1500lm	40°	22	1003592	
		1500lm	55°	22	1003595	
	4000 K	1600lm	20°	19	1003613	
		1600lm	40°	22	1003616	
		1600lm	55°	22	1003619	
	2700 K	1600lm	20°	22	1003566	
		1600lm	40°	22	1003569	
		1600lm	55°	22	1003572	
	3000 K	1600lm	20°	22	1003590	
		1600lm	40°	22	1003593	
		1600lm	55°	22	1003596	
	4000 K	1750lm	20°	22	1003614	
		1750lm	40°	22	1003617	
		1750lm	55°	22	1003620	
	2700 K	1550lm	20°	19	1003567	
		1550lm	40°	19	1003570	
		1550lm	55°	19	1003573	
	3000 K	1550lm	20°	19	1003591	
		1550lm	40°	19	1003594	
		1550lm	55°	19	1003597	
	4000 K	1660lm	20°	19	1003615	
		1660lm	40°	19	1003618	
		1660lm	55°	19	1003621	

NUMINOS® MOVE L



DL



Product details:

750mA
 Power consumption: 25.4W
 Material: aluminium/polycarbonate (PC)
 Installation dimensions: Diameter: 14.5 cm D: 10.5 cm

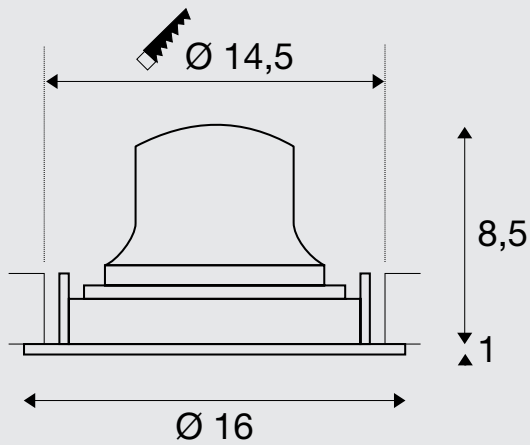

Tip:

Low-voltage plug
 Driver not included

You can find suitable drivers, diffusers, and reducer rings on pages 58-61.

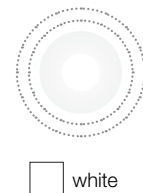
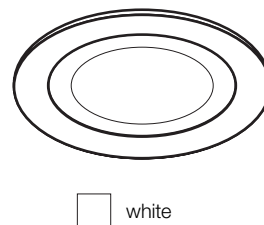
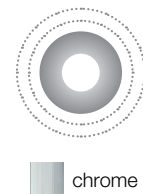
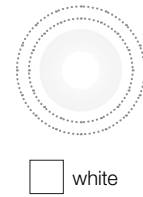
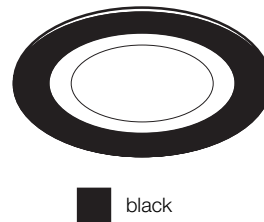
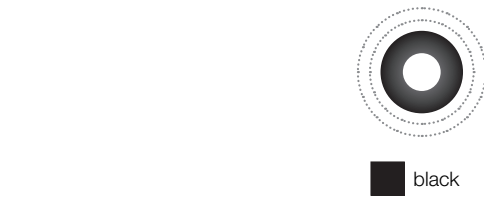

					PROD. NO.		
	2700 K	2150lm	20°	22	1003625		
		2150lm	40°	22	1003628		
		2150lm	55°	22	1003631		
	3000 K	2150lm	20°	22	1003649		
		2150lm	40°	22	1003652		
		2150lm	55°	25	1003655		
	4000 K	2350lm	20°	22	1003673		
		2350lm	40°	22	1003676		
		2350lm	55°	25	1003679		
	2700 K	2250lm	20°	19	1003626		
		2250lm	40°	19	1003629		
		2250lm	55°	22	1003632		
	3000 K	2300lm	20°	19	1003650		
		2300lm	40°	19	1003653		
		2300lm	55°	22	1003656		
	4000 K	2450lm	20°	19	1003674		
		2450lm	40°	19	1003677		
		2450lm	55°	22	1003680		
	2700 K	2150lm	20°	19	1003627		
		2150lm	40°	19	1003630		
		2150lm	55°	19	1003633		
	3000 K	2200lm	20°	19	1003651		
		2200lm	40°	19	1003654		
		2200lm	55°	19	1003657		
	4000 K	2350lm	20°	19	1003675		
		2350lm	40°	19	1003678		
		2350lm	55°	19	1003681		
	2700 K	2150lm	20°	22	1003637		
		2150lm	40°	22	1003640		
		2150lm	55°	22	1003643		
	3000 K	2150lm	20°	22	1003661		
		2150lm	40°	22	1003664		
		2150lm	55°	25	1003667		
	4000 K	2350lm	20°	22	1003685		
		2350lm	40°	22	1003688		
		2350lm	55°	25	1003691		
	2700 K	2250lm	20°	19	1003638		
		2250lm	40°	19	1003641		
		2250lm	55°	22	1003644		
	3000 K	2300lm	20°	19	1003662		
		2300lm	40°	19	1003665		
		2300lm	55°	22	1003668		
	4000 K	2450lm	20°	19	1003686		
		2450lm	40°	19	1003689		
		2450lm	55°	22	1003692		
	2700 K	2150lm	20°	19	1003639		
		2150lm	40°	19	1003642		
		2150lm	55°	19	1003645		
	3000 K	2200lm	20°	19	1003663		
		2200lm	40°	19	1003666		
		2200lm	55°	19	1003669		
	4000 K	2350lm	20°	19	1003687		
		2350lm	40°	19	1003690		
		2350lm	55°	19	1003693		

NUMINOS® MOVE XL



DL

XL



Product details:

1050mA
 Power consumption: 37.4W
 Material: aluminium/polycarbonate (PC)
 Installation dimensions: Diameter: 17.5 cm D: 13 cm

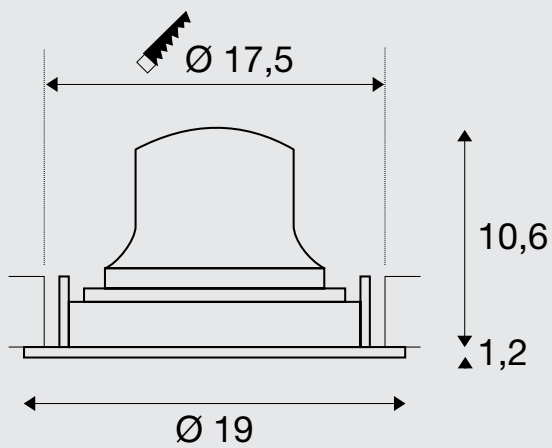

Tip:

Low-voltage plug
 Driver not included

You can find suitable drivers, diffusers, and reducer rings on pages 58-61.

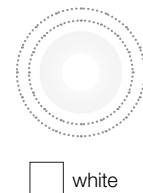
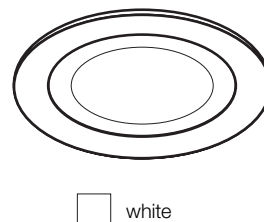
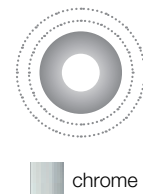
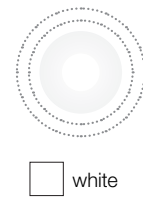
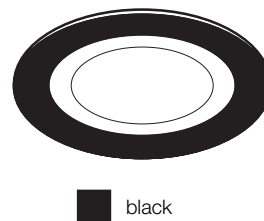

					PROD. NO.		
	2700 K	3300lm	20°	22	1003697		
		3300lm	40°	22	1003700		
		3300lm	55°	22	1003703		
	3000 K	3300lm	20°	22	1003721		
		3300lm	40°	22	1003724		
		3300lm	55°	22	1003727		
	4000 K	3600lm	20°	22	1003745		
		3600lm	40°	22	1003748		
		3600lm	55°	25	1003751		
	2700 K	3500lm	20°	19	1003698		
		3500lm	40°	19	1003701		
		3500lm	55°	19	1003704		
	3000 K	3550lm	20°	19	1003722		
		3550lm	40°	19	1003725		
		3550lm	55°	19	1003728		
	4000 K	3800lm	20°	19	1003746		
		3800lm	40°	19	1003749		
		3800lm	55°	19	1003752		
	2700 K	3400lm	20°	19	1003699		
		3400lm	40°	19	1003702		
		3400lm	55°	19	1003705		
	3000 K	3500lm	20°	19	1003723		
		3500lm	40°	19	1003726		
		3500lm	55°	19	1003729		
	4000 K	3750lm	20°	19	1003747		
		3750lm	40°	19	1003750		
		3750lm	55°	19	1003753		
	2700 K	3300lm	20°	22	1003709		
		3300lm	40°	22	1003712		
		3300lm	55°	22	1003715		
	3000 K	3300lm	20°	22	1003733		
		3300lm	40°	22	1003736		
		3300lm	55°	22	1003739		
	4000 K	3600lm	20°	22	1003757		
		3600lm	40°	22	1003760		
		3600lm	55°	25	1003763		
	2700 K	3500lm	20°	19	1003710		
		3500lm	40°	19	1003713		
		3500lm	55°	19	1003716		
	3000 K	3550lm	20°	19	1003734		
		3550lm	40°	19	1003737		
		3550lm	55°	19	1003740		
	4000 K	3800lm	20°	19	1003758		
		3800lm	40°	19	1003761		
		3800lm	55°	19	1003764		
	2700 K	3400lm	20°	19	1003711		
		3400lm	40°	19	1003714		
		3400lm	55°	19	1003717		
	3000 K	3500lm	20°	19	1003735		
		3500lm	40°	19	1003738		
		3500lm	55°	19	1003741		
	4000 K	3750lm	20°	19	1003759		
		3750lm	40°	19	1003762		
		3750lm	55°	19	1003765		

NUMINOS® GIMBLE XS



DL

XS



Product details:

200mA

Power consumption: 7W

Material: aluminium/polycarbonate (PC)

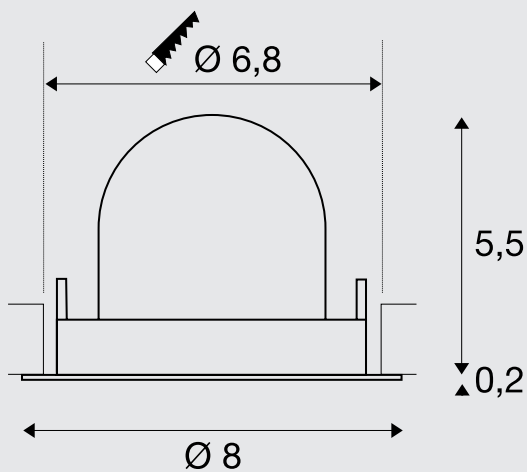
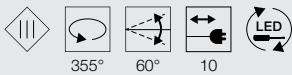

Tip:

Low-voltage plug
Driver not included

You can find suitable drivers, diffusers, and reducer rings on pages 58-61.



black

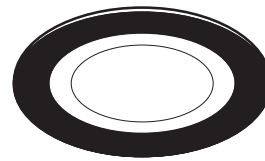

black



white



chrome



black

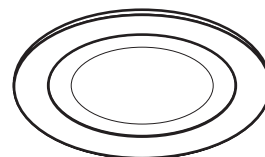

white



white



chrome

					PROD. NO.		
	2700 K	640lm	20°	16	1005813		
		620lm	40°	22	1005816		
		640lm	55°	25	1005819		
	3000 K	700lm	20°	16	1005831		
		670 lm	40°	22	1005834		
		690lm	55°	25	1005837		
	4000 K	720lm	20°	16	1005849		
		700lm	40°	22	1005852		
		710lm	55°	25	1005855		
	2700 K	670 lm	20°	16	1005814		
		650lm	40°	22	1005817		
		670 lm	55°	25	1005820		
	3000 K	730lm	20°	16	1005832		
		700lm	40°	22	1005835		
		720lm	55°	25	1005838		
	4000 K	750lm	20°	16	1005850		
		730lm	40°	22	1005853		
		740lm	55°	25	1005856		
	2700 K	670 lm	20°	16	1005815		
		650lm	40°	22	1005818		
		670 lm	55°	25	1005821		
	3000 K	730lm	20°	16	1005833		
		700lm	40°	22	1005836		
		720lm	55°	25	1005839		
	4000 K	750lm	20°	16	1005851		
		730lm	40°	22	1005854		
		740lm	55°	25	1005857		
	2700 K	640lm	20°	16	1005822		
		620lm	40°	22	1005825		
		640lm	55°	25	1005828		
	3000 K	700lm	20°	16	1005840		
		670 lm	40°	22	1005843		
		690lm	55°	25	1005846		
	4000 K	720lm	20°	16	1005858		
		700lm	40°	22	1005861		
		710lm	55°	25	1005864		
	2700 K	670 lm	20°	16	1005823		
		650lm	40°	22	1005826		
		670 lm	55°	25	1005829		
	3000 K	730lm	20°	16	1005841		
		700lm	40°	22	1005844		
		720lm	55°	25	1005847		
	4000 K	750lm	20°	16	1005859		
		730lm	40°	22	1005862		
		740lm	55°	25	1005865		
	2700 K	670 lm	20°	16	1005824		
		650lm	40°	22	1005827		
		670 lm	55°	25	1005830		
	3000 K	730lm	20°	16	1005842		
		700lm	40°	22	1005845		
		720lm	55°	25	1005848		
	4000 K	750lm	20°	16	1005860		
		730lm	40°	22	1005863		
		740lm	55°	25	1005866		

NUMINOS® GIMBLE S

NEW

LED
INSIDE



DL

S



Product details:

250mA

Power consumption: 8.6W

Material: aluminium/polycarbonate (PC)

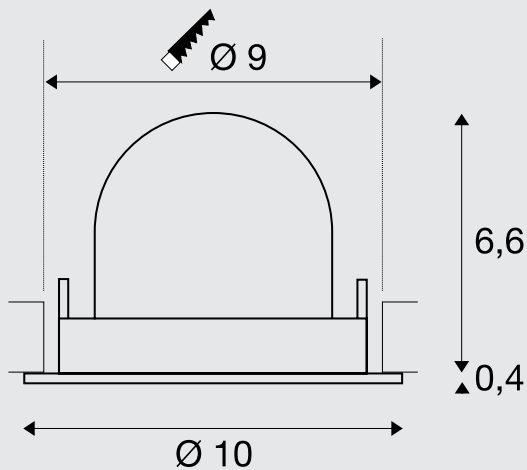
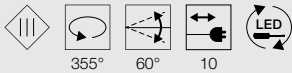

Tip:

Low-voltage plug
Driver not included

You can find suitable drivers, diffusers, and reducer rings on pages 58-61.

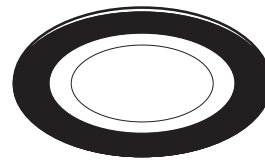

black



white



chrome



black

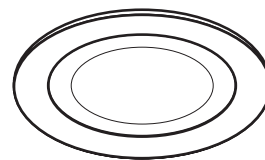

white



white



chrome

					PROD. NO.		
	2700 K	670 lm	20°	19	1005867		
		670 lm	40°	19	1005870		
		670 lm	55°	22	1005873		
	3000 K	690lm	20°	19	1005885		
		690lm	40°	19	1005888		
		690lm	55°	22	1005891		
	4000 K	730lm	20°	19	1005903		
		730lm	40°	19	1005906		
		730lm	55°	22	1005909		
	2700 K	720lm	20°	19	1005868		
		720lm	40°	19	1005871		
		720lm	55°	22	1005874		
	3000 K	730lm	20°	19	1005886		
		730lm	40°	19	1005889		
		730lm	55°	22	1005892		
	4000 K	790lm	20°	19	1005904		
		790lm	40°	19	1005907		
		790lm	55°	22	1005910		
	2700 K	690lm	20°	19	1005869		
		690lm	40°	19	1005872		
		690lm	55°	22	1005875		
	3000 K	700lm	20°	19	1005887		
		700lm	40°	19	1005890		
		700lm	55°	22	1005893		
	4000 K	750lm	20°	19	1005905		
		750lm	40°	19	1005908		
		750lm	55°	22	1005911		
	2700 K	670 lm	20°	19	1005876		
		670 lm	40°	19	1005879		
		670 lm	55°	22	1005882		
	3000 K	690lm	20°	19	1005894		
		690lm	40°	19	1005897		
		690lm	55°	22	1005900		
	4000 K	730lm	20°	19	1005912		
		730lm	40°	19	1005915		
		730lm	55°	22	1005918		
	2700 K	720lm	20°	19	1005877		
		720lm	40°	19	1005880		
		720lm	55°	22	1005883		
	3000 K	730lm	20°	19	1005895		
		730lm	40°	19	1005898		
		730lm	55°	22	1005901		
	4000 K	790lm	20°	19	1005913		
		790lm	40°	19	1005916		
		790lm	55°	22	1005919		
	2700 K	690lm	20°	19	1005878		
		690lm	40°	19	1005881		
		690lm	55°	22	1005884		
	3000 K	700lm	20°	19	1005896		
		700lm	40°	19	1005899		
		700lm	55°	22	1005902		
	4000 K	750lm	20°	19	1005914		
		750lm	40°	19	1005917		
		750lm	55°	22	1005920		

NUMINOS® GIMBLE M



DL

M



Product details:

500mA

Power consumption: 17.5W

Material: aluminium/polycarbonate (PC)

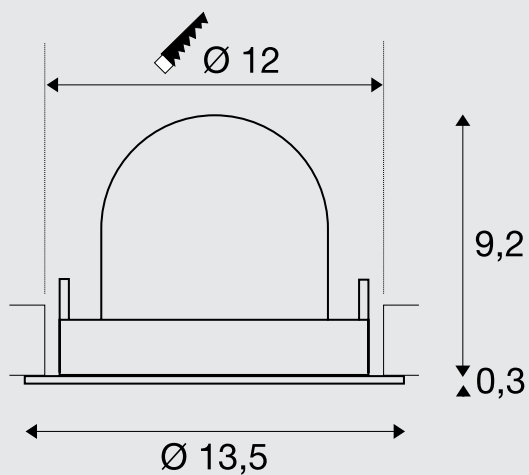
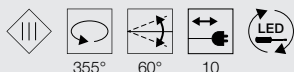

Tip:

Low-voltage plug
Driver not included

You can find suitable drivers, diffusers, and reducer rings on pages 58-61.



black

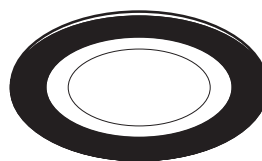

black



white



chrome



black

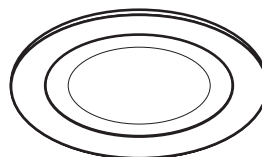

white



white



chrome

					PROD. NO.	
	2700 K	1460lm	20°	22	1005921	
		1460lm	40°	22	1005924	
		1460lm	55°	22	1005927	
	3000 K	1500lm	20°	22	1005939	
		1500lm	40°	22	1005942	
		1500lm	55°	22	1005945	
	4000 K	1600lm	20°	22	1005957	
		1600lm	40°	22	1005960	
		1600lm	55°	22	1005963	
	2700 K	1600lm	20°	22	1005922	
		1600lm	40°	22	1005925	
		1600lm	55°	22	1005928	
	3000 K	1600lm	20°	22	1005940	
		1600lm	40°	22	1005943	
		1600lm	55°	22	1005946	
	4000 K	1750lm	20°	22	1005958	
		1750lm	40°	22	1005961	
		1750lm	55°	22	1005964	
	2700 K	1550lm	20°	22	1005923	
		1550lm	40°	22	1005926	
		1550lm	55°	22	1005929	
	3000 K	1550lm	20°	22	1005941	
		1550lm	40°	22	1005944	
		1550lm	55°	22	1005947	
	4000 K	1660lm	20°	22	1005959	
		1660lm	40°	22	1005962	
		1660lm	55°	22	1005965	
	2700 K	1460lm	20°	22	1005930	
		1460lm	40°	22	1005933	
		1460lm	55°	22	1005936	
	3000 K	1500lm	20°	22	1005948	
		1500lm	40°	22	1005951	
		1500lm	55°	22	1005954	
	4000 K	1600lm	20°	22	1005966	
		1600lm	40°	22	1005969	
		1600lm	55°	22	1005972	
	2700 K	1600lm	20°	22	1005931	
		1600lm	40°	22	1005934	
		1600lm	55°	22	1005937	
	3000 K	1600lm	20°	22	1005949	
		1600lm	40°	22	1005952	
		1600lm	55°	22	1005955	
	4000 K	1750lm	20°	22	1005967	
		1750lm	40°	22	1005970	
		1750lm	55°	22	1005973	
	2700 K	1550lm	20°	22	1005932	
		1550lm	40°	22	1005935	
		1550lm	55°	22	1005938	
	3000 K	1550lm	20°	22	1005950	
		1550lm	40°	22	1005953	
		1550lm	55°	22	1005956	
	4000 K	1660lm	20°	22	1005968	
		1660lm	40°	22	1005971	
		1660lm	55°	22	1005974	

NUMINOS® GIMBLE L



DL



Product details:

700mA

Power consumption: 25.4W

Material: aluminium/polycarbonate (PC)

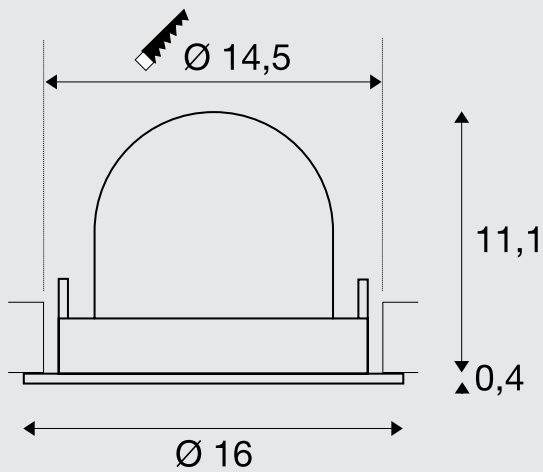
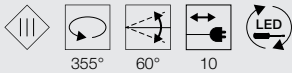

Tip:

Low-voltage plug
Driver not included

You can find suitable drivers, diffusers, and reducer rings on pages 58-61.

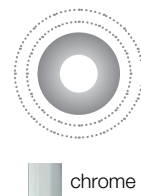
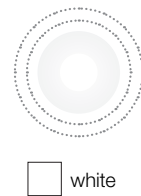
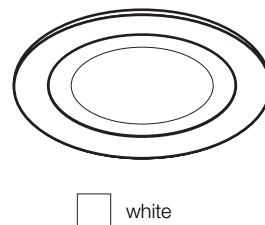
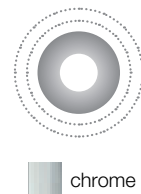
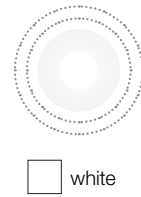
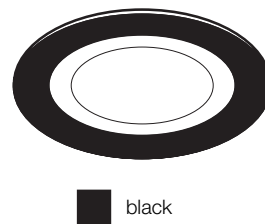

					PROD. NO.	
	2700 K	2150lm	20°	22	1005975	
		2150lm	40°	22	1005978	
		2150lm	55°	22	1005981	
	3000 K	2150lm	20°	22	1005993	
		2150lm	40°	22	1005996	
		2150lm	55°	22	1005999	
	4000 K	2350lm	20°	22	1006011	
		2350lm	40°	22	1006014	
		2350lm	55°	22	1006017	
	2700 K	2250lm	20°	22	1005976	
		2250lm	40°	22	1005979	
		2250lm	55°	22	1005982	
	3000 K	2300lm	20°	22	1005994	
		2300lm	40°	22	1005997	
		2300lm	55°	22	1006000	
	4000 K	2450lm	20°	22	1006012	
		2450lm	40°	22	1006015	
		2450lm	55°	22	1006018	
	2700 K	2150lm	20°	22	1005977	
		2150lm	40°	22	1005980	
		2150lm	55°	22	1005983	
	3000 K	2200lm	20°	22	1005995	
		2200lm	40°	22	1005998	
		2200lm	55°	22	1006001	
	4000 K	2350lm	20°	22	1006013	
		2350lm	40°	22	1006016	
		2350lm	55°	22	1006019	
	2700 K	2150lm	20°	22	1005984	
		2150lm	40°	22	1005987	
		2150lm	55°	22	1005990	
	3000 K	2150lm	20°	22	1006002	
		2150lm	40°	22	1006005	
		2150lm	55°	22	1006008	
	4000 K	2350lm	20°	22	1006020	
		2350lm	40°	22	1006023	
		2350lm	55°	22	1006026	
	2700 K	2250lm	20°	22	1005985	
		2250lm	40°	22	1005988	
		2250lm	55°	22	1005991	
	3000 K	2300lm	20°	22	1006003	
		2300lm	40°	22	1006006	
		2300lm	55°	22	1006009	
	4000 K	2450lm	20°	22	1006021	
		2450lm	40°	22	1006024	
		2450lm	55°	22	1006027	
	2700 K	2150lm	20°	22	1005986	
		2150lm	40°	22	1005989	
		2150lm	55°	22	1005992	
	3000 K	2200lm	20°	22	1006004	
		2200lm	40°	22	1006007	
		2200lm	55°	22	1006010	
	4000 K	2350lm	20°	22	1006022	
		2350lm	40°	22	1006025	
		2350lm	55°	22	1006028	

NUMINOS® GIMBLE XL



DL

XL



Product details:

1000/1050mA

Power consumption: 37.4W

Material: aluminium/polycarbonate (PC)

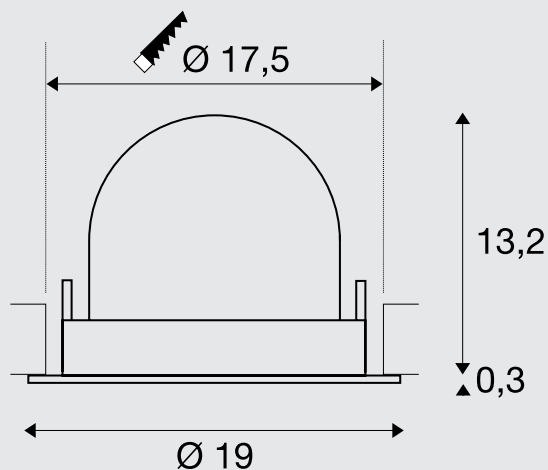
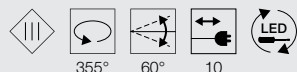

Tip:

Low-voltage plug
Driver not included

You can find suitable drivers, diffusers, and reducer rings on pages 58-61.

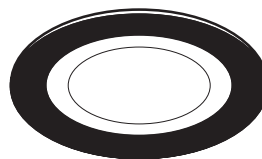

black



white



chrome



black

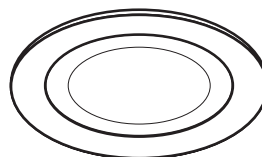

white



white



chrome

					PROD. NO.		
	2700 K	3300lm	20°	22	1006029		
		3300lm	40°	22	1006032		
		3300lm	55°	22	1006035		
	3000 K	3300lm	20°	22	1006047		
		3300lm	40°	22	1006050		
		3300lm	55°	22	1006053		
	4000 K	3600lm	20°	22	1006065		
		3600lm	40°	22	1006068		
		3600lm	55°	22	1006071		
	2700 K	3500lm	20°	22	1006030		
		3500lm	40°	22	1006033		
		3500lm	55°	22	1006036		
	3000 K	3550lm	20°	22	1006048		
		3550lm	40°	22	1006051		
		3550lm	55°	22	1006054		
	4000 K	3800lm	20°	22	1006066		
		3800lm	40°	22	1006069		
		3800lm	55°	22	1006072		
	2700 K	3400lm	20°	22	1006031		
		3400lm	40°	22	1006034		
		3400lm	55°	22	1006037		
	3000 K	3500lm	20°	22	1006049		
		3500lm	40°	22	1006052		
		3500lm	55°	22	1006055		
	4000 K	3750lm	20°	22	1006067		
		3750lm	40°	22	1006070		
		3750lm	55°	22	1006073		
	2700 K	3300lm	20°	22	1006038		
		3300lm	40°	22	1006041		
		3300lm	55°	22	1006044		
	3000 K	3300lm	20°	22	1006056		
		3300lm	40°	22	1006059		
		3300lm	55°	22	1006062		
	4000 K	3600lm	20°	22	1006074		
		3600lm	40°	22	1006077		
		3600lm	55°	22	1006080		
	2700 K	3500lm	20°	22	1006039		
		3500lm	40°	22	1006042		
		3500lm	55°	22	1006045		
	3000 K	3550lm	20°	22	1006057		
		3550lm	40°	22	1006060		
		3550lm	55°	22	1006063		
	4000 K	3800lm	20°	22	1006075		
		3800lm	40°	22	1006078		
		3800lm	55°	22	1006081		
	2700 K	3400lm	20°	22	1006040		
		3400lm	40°	22	1006043		
		3400lm	55°	22	1006046		
	3000 K	3500lm	20°	22	1006058		
		3500lm	40°	22	1006061		
		3500lm	55°	22	1006064		
	4000 K	3750lm	20°	22	1006076		
		3750lm	40°	22	1006079		
		3750lm	55°	22	1006082		









Accessories





Perfect driver assignment

	NEW	NEW	NEW			
	LED Driver, 200mA, 10W QC	LED Driver, 200mA, 10W, PHASE QC	LED Driver 200mA, 30W, DALI QC	LED driver 250mA, 10W	LED driver 250mA, 10W, PHASE	LED driver 250mA, 20W, DALI
	XS	XS	XS	S	S	S
	200mA	200mA	200mA	250mA	250mA	250/350/500/700mA
Material	Polycarbonate (PC)	Polycarbonate (PC)	Polycarbonate (PC)	Polycarbonate (PC)	Polycarbonate (PC)	Polycarbonate (PC)
Colour	white	white	white	white	white	white
Voltage prim.	200-240V ~50/60Hz	200-240V ~50/60Hz	200-240V ~50/60Hz	220-240V ~50/60Hz	220-240V ~50/60Hz	220-240V ~50/60Hz
Voltage sec.	29-42V DC	30-42V DC	15-54V DC	26-40V	30-42V	6-60V
Output current	200mA	200mA	200mA	250mA	250mA	250mA
Number of outputs sec.	1	1	1	1	1	1
Wattage of	5.8W	6W	3.8W	6.5W	7.5W	1.5W
Wattage up to	8.4W	8.4W	13.5W	10W	10W	15W
Environmental temp. min.	-	-	-	-20°C	-20°C	-20°C
Environmental temp. max.	-	-	-	45°C	50°C	50°C
Thermal protection	110°C	110°C	110°C	110°C	110°C	110°C
IP protection rating	IP 20	IP 20	IP 20	IP 20	IP 20	IP 20
Dimmable	-	PHASE C	DALI	-	PHASE C	DALI
Length	6.5 cm	8.5 cm	18 cm	6.5 cm	8.5 cm	15 cm
Width	3.9 cm	4.1cm	4.5 cm	3.9 cm	3.9 cm	5.2 cm
Height	3.5cm	3 cm	3 cm	2 cm	2.2 cm	2.8 cm
Prod. no.	1005610	1005609	1005611	1004058	1004055	1004067

Diffusers

	XS				S			
	NEW	NEW	NEW	NEW				
	Diffuser elliptical	Diffuser prismatic	Diffuser frosted	Diffuser honeycomb	Diffuser elliptical	Diffuser prismatic	Diffuser frosted	Diffuser honeycomb
Prod. no.	1005612	1005613	1005614	1005615	1004786	1004787	1004788	1004789

			
	LED driver 500mA, 30W	LED driver 500mA, 30W, PHASE	LED driver 500mA, 40W, DALI
			
			
	500/600/700mA	500mA	250/350/500/700mA
Material	Polycarbonate (PC)	Polycarbonate (PC)	Polycarbonate (PC)
Colour	white	white	white
Voltage prim.	220-240V ~50/60Hz	220-240V ~50/60Hz	220-240V ~50/60Hz
Voltage sec.	30-42V	25-42V	6-58V
Output current	500mA	500mA	500mA
Number of outputs sec.	1	1	1
Wattage of	15W	12.5W	1.5W
Wattage up to	29.5W	21W	40.6W
Environmental temp. min.	-20°C	-25°C	-25°C
Environmental temp. max.	50°C	50°C	50°C
Thermal protection	110°C	110°C	110°C
IP protection rating	IP 20	IP 20	IP 20
Dimmable	-	PHASE C	DALI
Length	14.7 cm	11.5W	12.3 cm
Width	4.3 cm	4.1cm	7.9 cm
Height	3 cm	2.5 cm	2.4 cm
Prod. no.	1004064	1004054	1004069

				
				
	Diffuser elliptical	Diffuser prismatic	Diffuser frosted	Diffuser honeycomb
Prod. no.	1004790	1004791	1004792	1004793

Accessories

Perfect driver assignment

	LED driver 1050mA, 40W	LED driver 700mA, 30W, PHASE	LED driver 700mA, 40W, DALI	LED driver 1050mA, 40W	LED driver 1000mA, 40W, PHASE	LED driver 1050mA, 50W, DALI
	L	L	L	XL	XL	XL
	500/600/700mA	700mA	700mA	800/900/1050mA	1000mA	1050mA
Material	Polycarbonate (PC)	Polycarbonate (PC)	Polycarbonate (PC)	Polycarbonate (PC)	Polycarbonate (PC)	Polycarbonate (PC)
Colour	white	white	white	white	white	white
Voltage prim.	220-240V ~50/60Hz	220-240V ~50/60Hz	220-240V ~50/60Hz	220-240V ~50/60Hz	220-240V ~50/60Hz	220-240V ~50/60Hz
Voltage sec.	30-42V	30-42V	6-58V	30-42V	25-40V DC	6-58V
Output current	700mA	700mA	250/350/500/700mA	1050mA	1050mA	1050mA
Number of outputs sec.	1	1	1	1	1	1
Wattage of	15W	21W	1.5W	24W	26.3W	4.2W
Wattage up to	29.5W	29.4W	40.6W	44W	42W	50W
Environmental temp. min.	-20°C	-20°C	-25°C	-20°C	-20°C	-25°C
Environmental temp. max.	50°C	50°C	50°C	50°C	50°C	50°C
Thermal protection	110°C	110°C	110°C	110°C	110°C	110°C
IP protection rating	IP 20	IP 20	IP 20	IP 20	IP 20	IP 20
Dimmable	-	PHASE C	DALI	-	PHASE C	DALI
Length	14.7 cm	11.5W	12.3 cm	9.7 cm	14.5 cm	12.3 cm
Width	4.3 cm	4.4 cm	7.9 cm	4.3 cm	4 cm	7.9 cm
Height	3 cm	3 cm	2.4 cm	3 cm	3 cm	2.4 cm
Prod. no.	1004062	1004065	1004070	1004059	1004066	1004071

Diffusers

	L				XL			
	Diffuser elliptical	Diffuser prismatic	Diffuser frosted	Diffuser honeycomb	Diffuser elliptical	Diffuser prismatic	Diffuser frosted	Diffuser honeycomb
Prod. no.	1004794	1004795	1004796	1004797	1004798	1004799	1004800	1004801

NEW

TIME FOR A CHANGE. TIME FOR AN UPDATE.

An old recessed ceiling light, often still fitted with conventional bulbs, should give way to an energy-efficient and cost-effective alternative. When removing the old fitting, a larger ceiling cut-out will often be required than before.

Here SLV offers the appropriate solution – our new reducer rings.

The reducer rings completely cover the larger ceiling cut-out, while at the same time providing perfect support for your new, compact, recessed ceiling light.

Neat, time-saving, uncomplicated.

And also perfectly tailored to the NUMINOS® Downlight and Spotlight system.



1. Old recessed ceiling light with larger ceiling cut-out.



2. Removal of the old recessed ceiling light.



3. Installation of the reducer ring.



4. Reducer ring installed. Larger ceiling cut-out fully covered.



5. Electrical connection and installation of the new recessed ceiling light.



6. New recessed ceiling light placed into the reducer ring.

Reducer ring, round



Material	steel	steel	steel	steel	steel
External Ø	16 cm	16 cm	24 cm	24 cm	24 cm
Height	5.3 cm	5.3 cm	5.3 cm	5.3 cm	5.3 cm
Internal Ø	7 cm	9 cm	12 cm	15 cm	18 cm
Ceiling cut-out	8.5-13 cm	12-15 cm	14-18 cm	17-20 cm	20-22 cm
Material thickness	3 cm	3 cm	3 cm	3 cm	3 cm
Prod. no. black	1006135	1006139	1006143	1006147	1006151
Prod. no. white	1006136	1006140	1006144	1006148	1006152

Reducer ring, square



Material	steel	steel	steel	steel	steel
Length	16 cm	16 cm	24 cm	24 cm	24 cm
Width	16 cm	16 cm	24 cm	24 cm	24 cm
Height	5.3 cm	5.3 cm	5.3 cm	5.3 cm	5.3 cm
Internal Ø	7 cm	9 cm	12 cm	15 cm	18 cm
Ceiling cut-out	8.5-13 cm	12-15 cm	14-18 cm	17-20 cm	20-22 cm
Material thickness	3 cm	3 cm	3 cm	3 cm	3 cm
Prod. no. black	1006137	1006141	1006145	1006149	1006153
Prod. no. white	1006138	1006142	1006146	1006150	1006154